

MC50.2.52

CAM MENTEŞESİ - 50
GLASS HINGE - 50

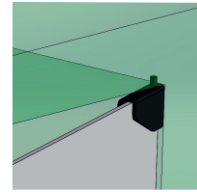
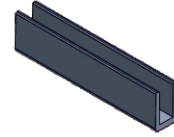
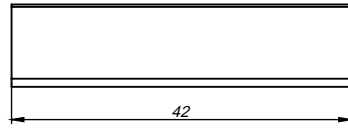
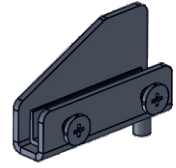
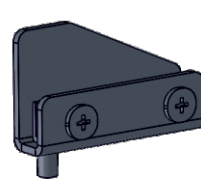
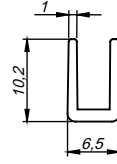
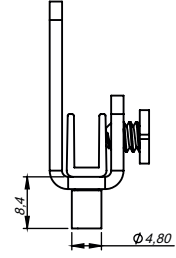
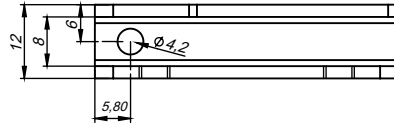
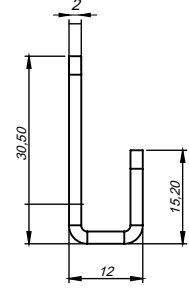
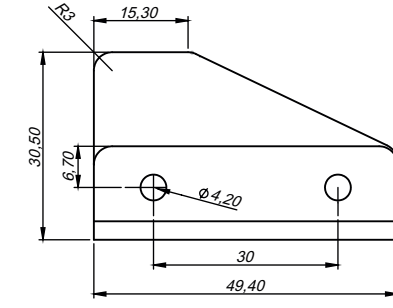
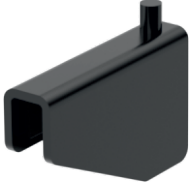

Kullanım Alanları

- * Büro Mobilyaları
- * Çeşitli Panolar
- * Bilgisayar Kabineleri

Malzeme

- * Gövde: Çelik
- * Civata: Çelik
- * Yatak: Polietilen

Applications

- * Office Furnitures
- * Electrical Panels
- * Server Cabinet

Material

- * Body: Steel
- * Screw: Steel
- * Busing: Polyethylene

